

CORI

FIRE PIT  
CATALOGUE

---

2025



## INDEX



01



02



03

# CORI



Size :  $\phi$ 15cm\*H20cm



ORANGE



BLUE



BLACK



ORIGINAL



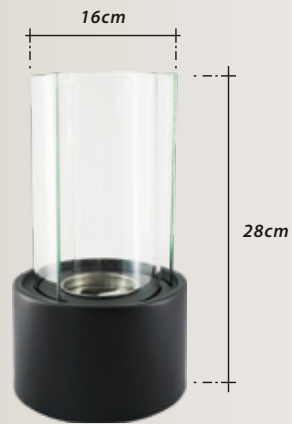

Size :  $\phi 16\text{cm} \times \text{H}28\text{cm}$



BLACK

WHITE

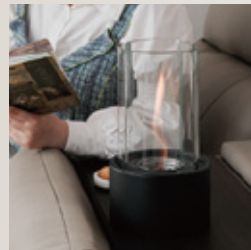



Size :  $\phi 16\text{cm} \times \text{H}28\text{cm}$



BLACK

WHITE

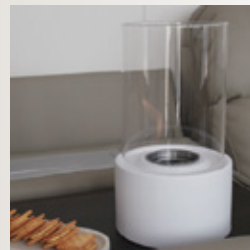
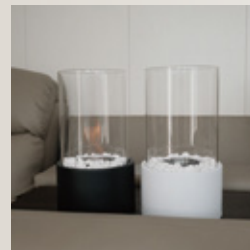



Size :  $\phi 16\text{cm} \times \text{H}28\text{cm}$



BLACK



WHITE

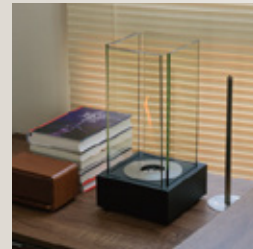



**Size:** 35cm\*H14.5cm



BLACK



WHITE

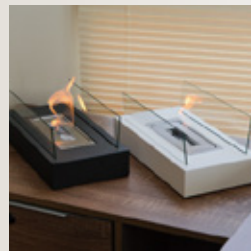



Size : 35cm\*H14.5cm



BLACK

WHITE

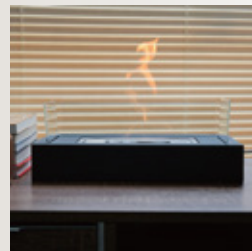
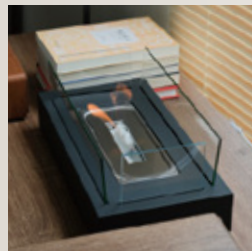

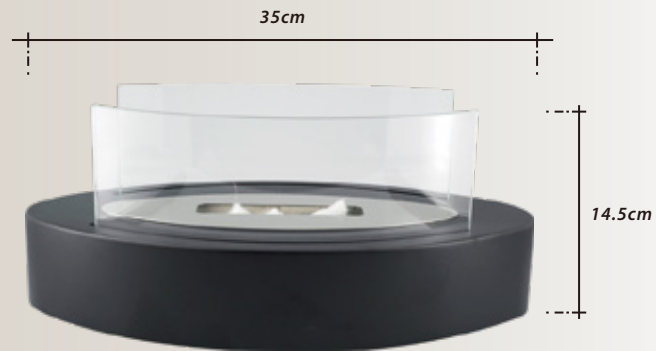

Size : 35cm\*H14.5cm



BLACK

WHITE

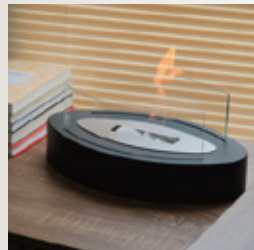
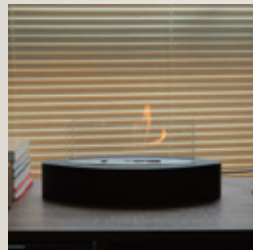



Size : 16cm\*H51cm



ORIGINAL

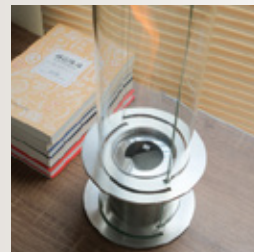
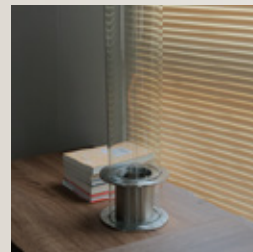



BLACK



WHITE

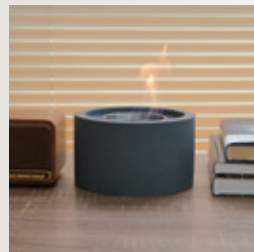
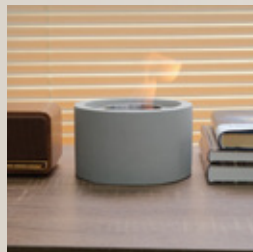

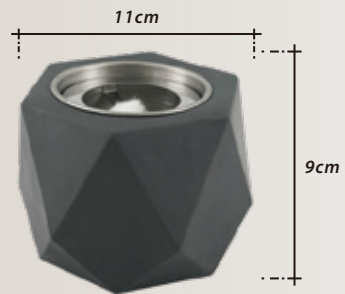

BLACK

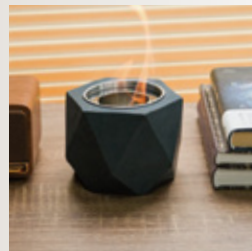
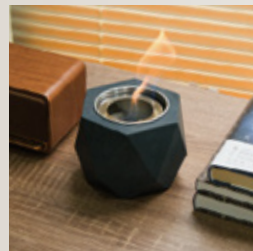
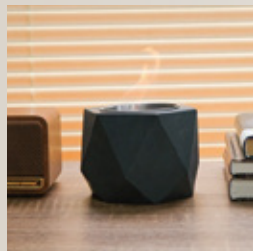

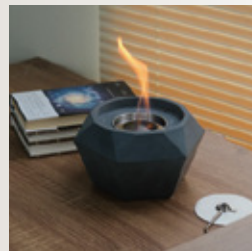
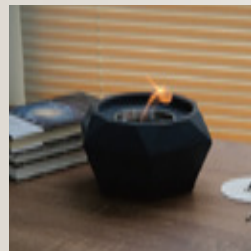
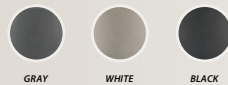
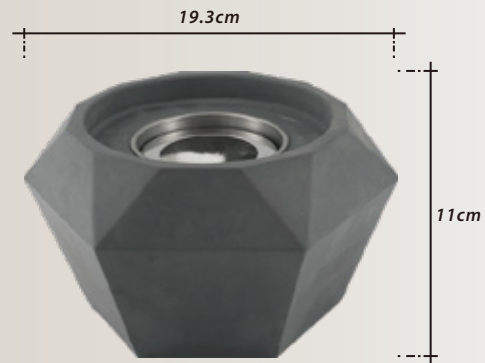



WHITE+GRAY



GRAY+WHITE

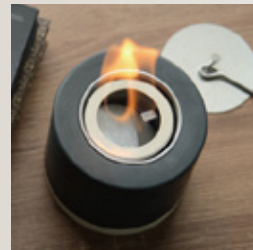
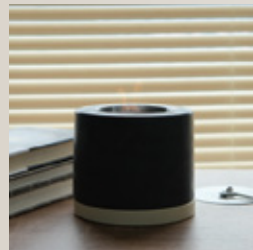

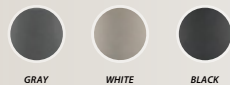
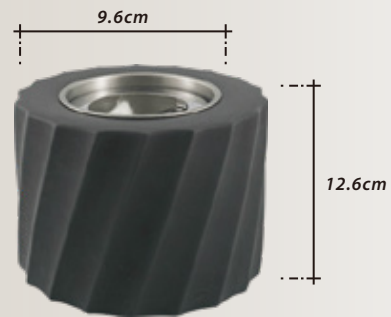

GRAY

WHITE

BLACK

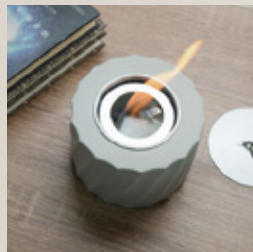

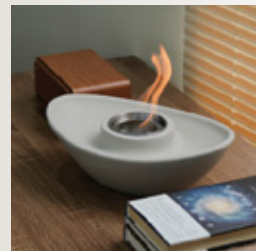
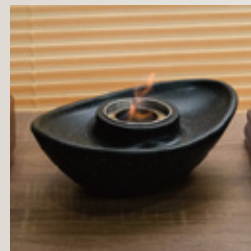
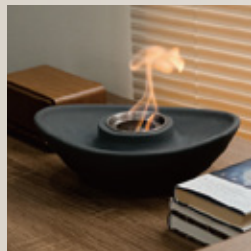
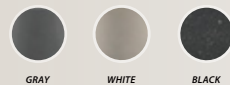



BROWN

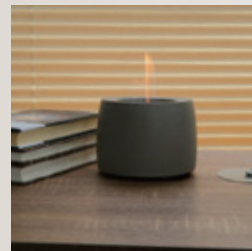
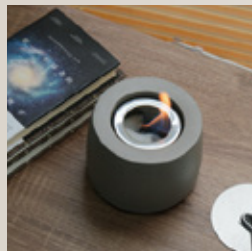

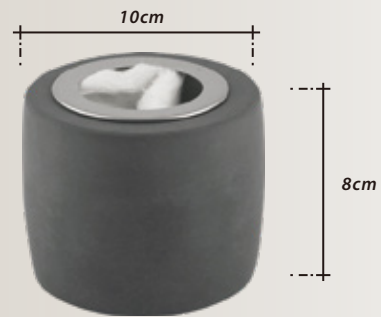

BLACK

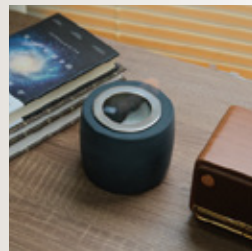
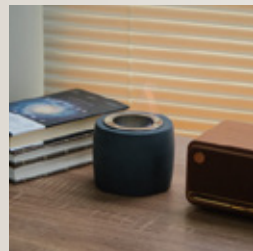
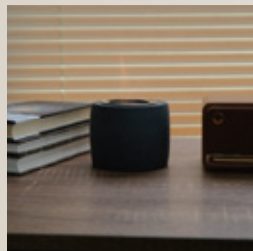

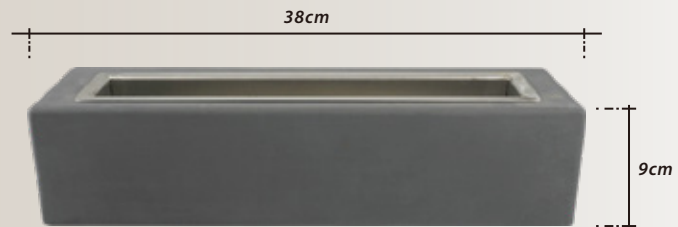

GRAY



WHITE

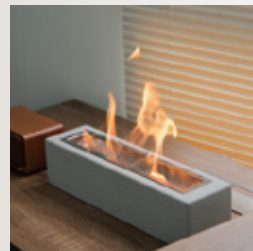

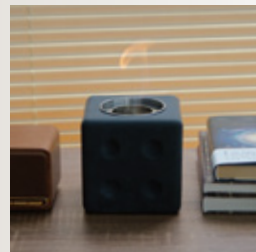
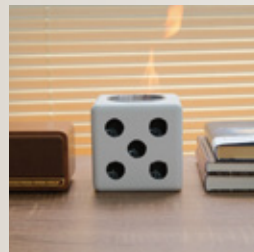
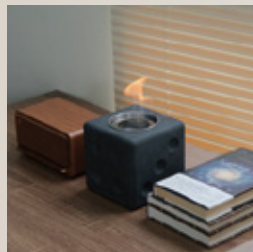
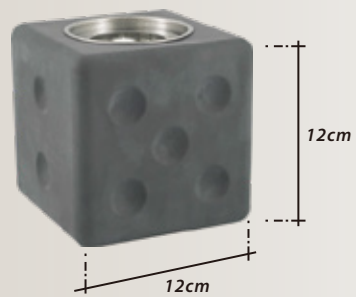

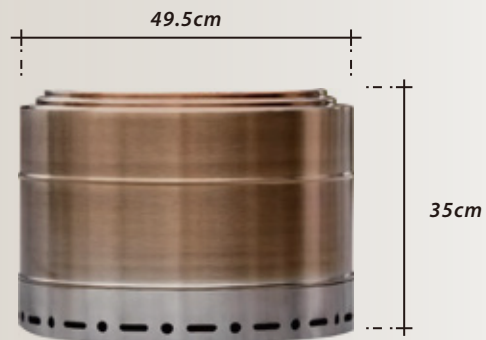



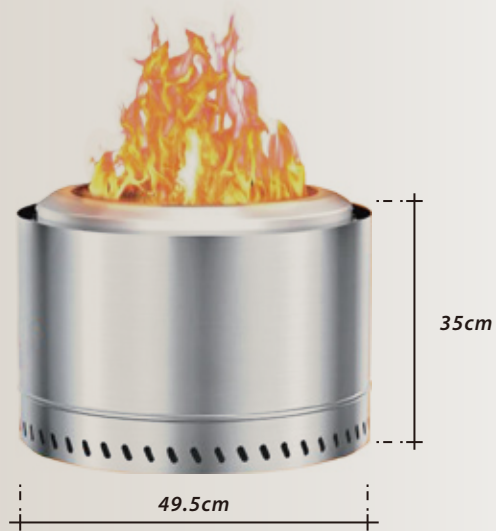

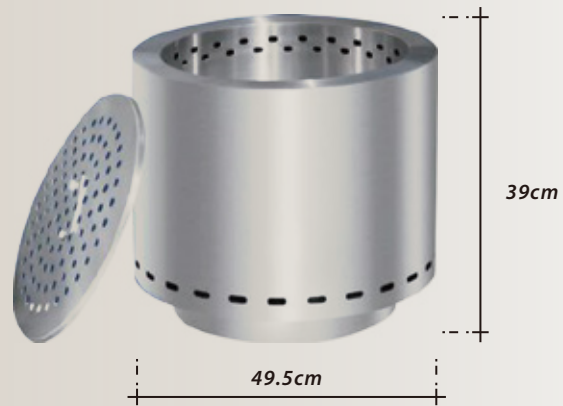

**Reinforced Vent  
Holes and Ash Pan**



**Bottom Support for  
Safe Burning**



**360° Signature  
Airflow Technology**



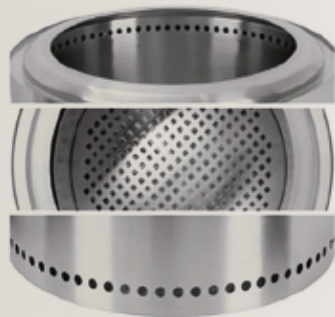
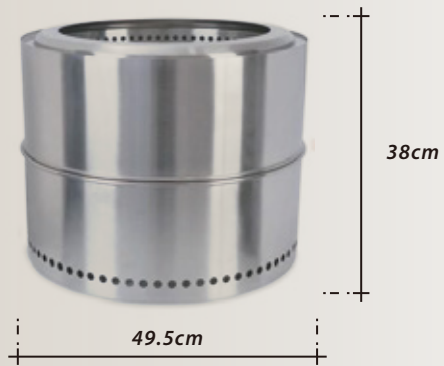



**Burning Particles**



**Burning Wood**



**FireStarters Squares**





Burning Particles



Burning Wood



FireStarters Squares





**Burning Particles**



**Burning Wood**



**FireStarters Squares**







**Burning Particles**



**Burning Wood**



**FireStarters Squares**





## ABOUT US

MOHOM is a company focusing on cement household products, and the factory has 20 years of experience. We are a highly experimental, exploratory, borderless, cross-border and prolific brand. We are committed to the innovative research and development and design of cement products. We are committed to bringing more possibilities to cement through a series of design-based process innovations. Let cement return to its essence, restore its unique texture, and make it into products that meet our daily needs.

MOHOM integrates R&D, design, production, sales and promotion. At present, the products cover bathroom products, household products, desktop stoves, etc. We pursue the positioning and inspection of our products with international standards. Each product is independently designed and customized with high quality. The products and materials are certified by professional quality testing agencies such as CE, CUPc, and ROHS2.0.

## WHY CHOOSE US



# PRODUCTION EQUIPMENT

# CORI



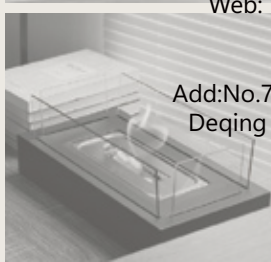
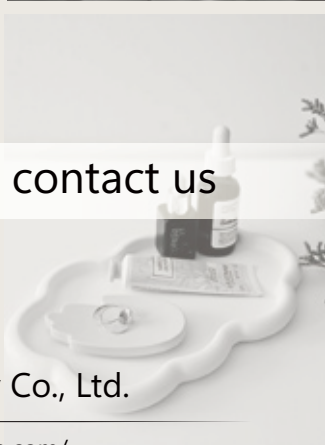

More customization contact us

Zhejiang Huli Technology Co., Ltd.

Web: <https://CORI.en.alibaba.com/>

Email: S2@cncori.com

Tel: +86 18805827307

Add: No.7 Shizhai, Longshan, Fuxi Street,  
Deqing County, Huzhou City, Zhejiang  
Province

